

Presiune maxima de functionare / Max working pressure : 10 BAR
 Presiune minima de functionare / Min working pressure : 0.1 BAR
 Temperatura maxima la intrare / Max working temperature : 90 °C

Termostat de siguranta / Safety thermostat
 Setare fabrica / Default set : 65°C
 Contact : Normal inchis / Contact : Normal closed
 Grad de protectie / Protection : IP67
 Temperatura maxima / Max temperature : 150°C

Sensor la distanta cap termostatat / Thermostat head sensor

Model pompa / Circulator model : Wilo Para 25/7 SC
 Alimentare electrica / Power supply : 230V +10%/-15%, 50/60Hz
 Distanța între axe / Centre distance : 130 mm
 Prinderi cu filet / Connection : G1"1/2
 Temperatura de folosire / Temperature range : 0-95°C
 Presiune maxima de folosire / Max working pressure : PN10

Cap termostatic de reglare / Regulation thermostatic head
 Presiune maxima statica de lucru / Max static working pressure: 10 bar
 Temperatura maxima de lucru / Max working temperature: 120°C
 Presiune maxima diferentiala / Max differential pressure: 1 bar
 Interval de reglare / Regulating range: 20-65°C
 Lungime capilar / Capillary length: 2m

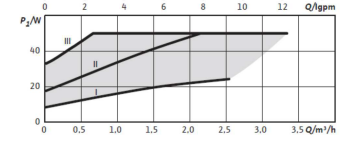
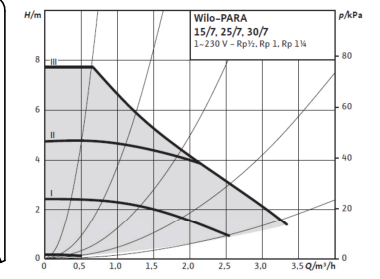
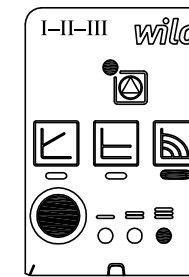
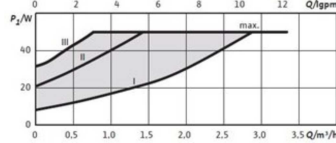
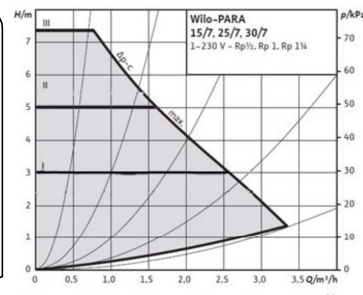
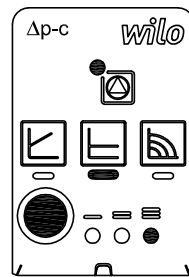
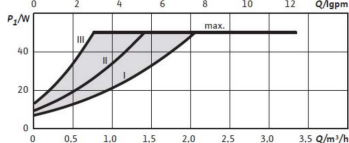
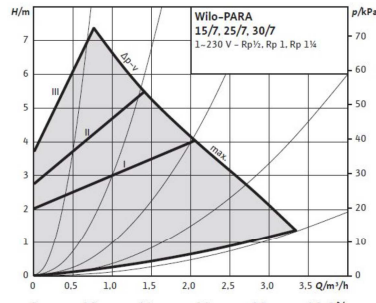
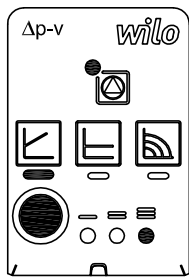
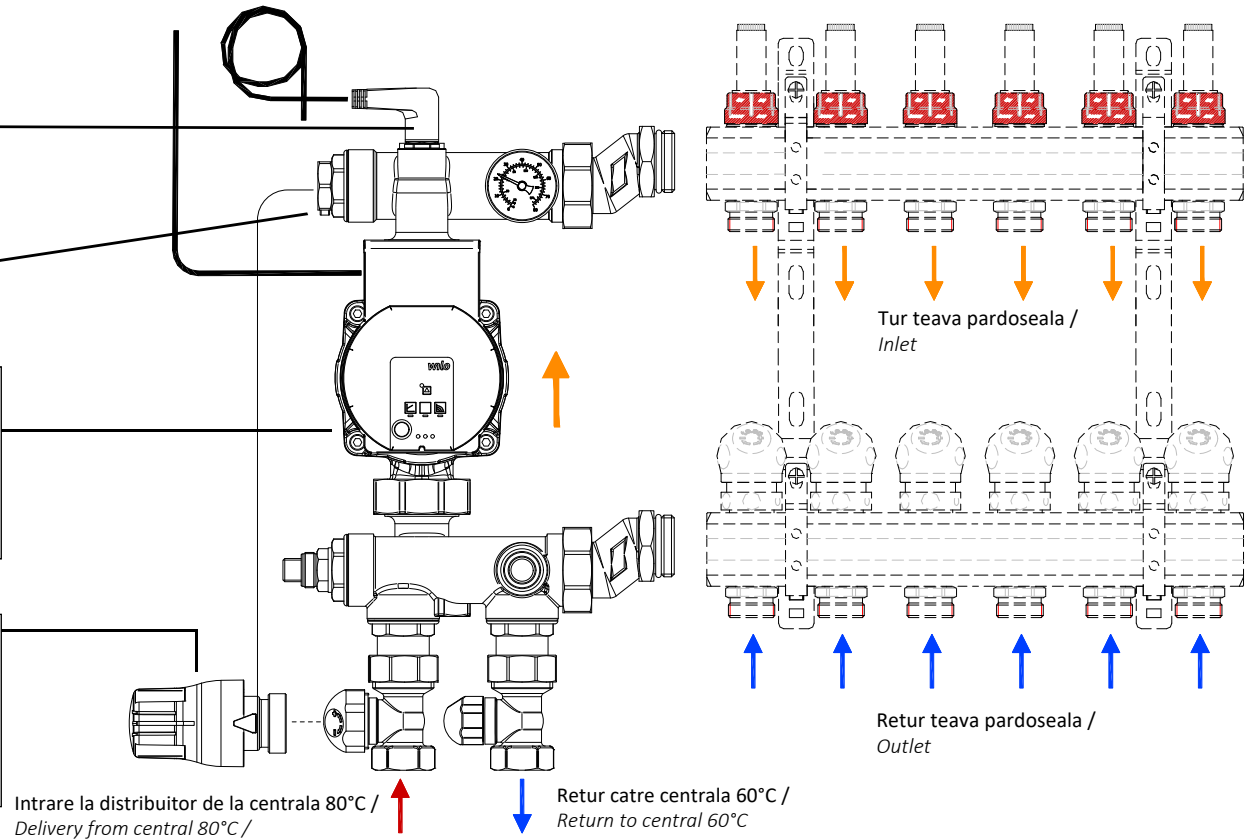

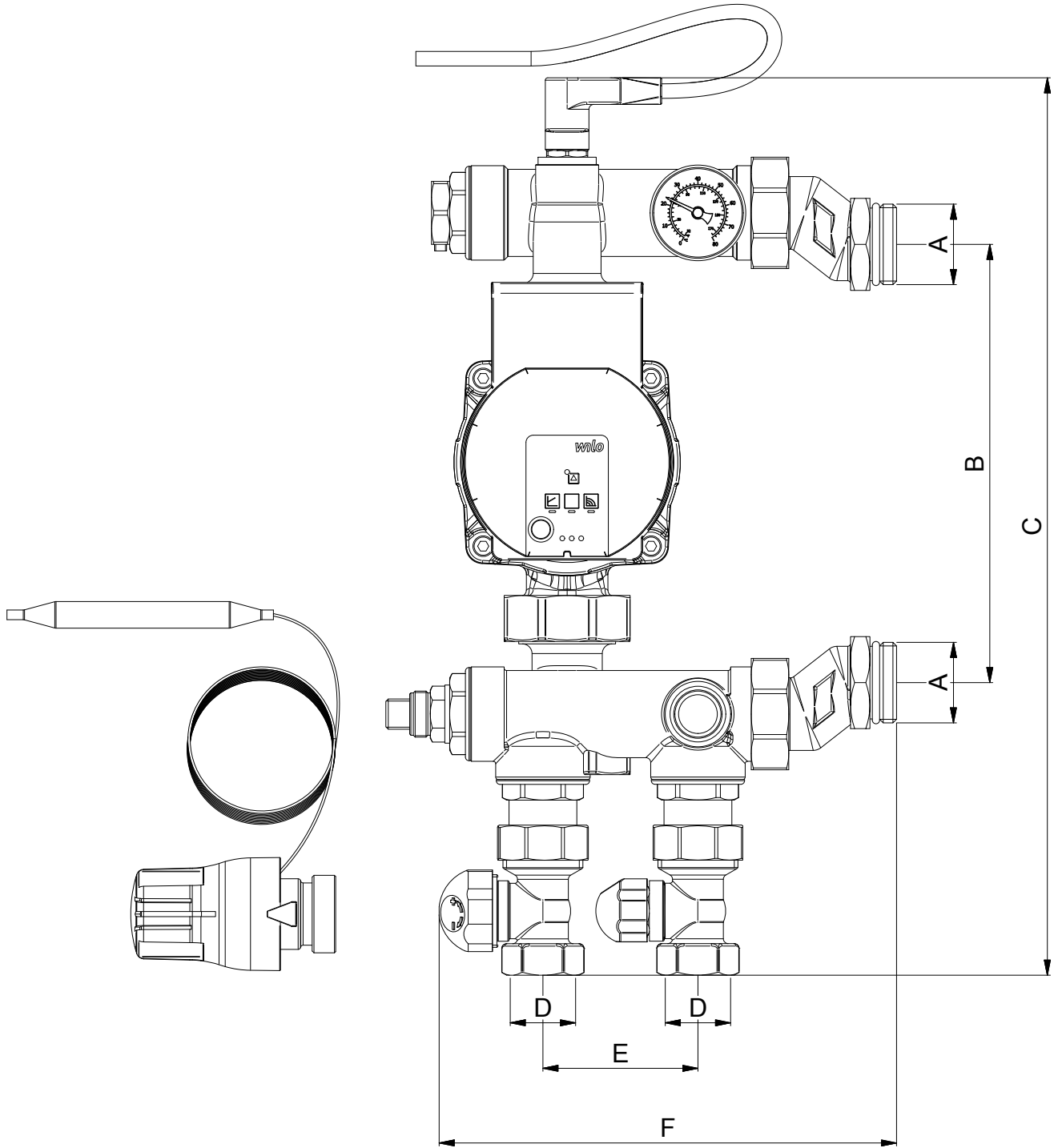

Art.	A	B	C	D	E	F
249KE-065-8763	1" M	181+231	370	3/4" F	64	190